



ADVANCED WARNING

SYSTEMS

ZoneSense



Fire Alarm Control Panel

User Manual & Log Book EN54 2 & 4

MAN 2748-11

WORLD LEADER OF INNOVATIVE SOLUTIONS
IN FIRE DETECTION AND ALARM SYSTEMS

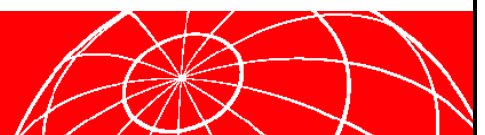

Responding To An Alarm

Access Level 1 (Normal Operation)

1. Indicators

Zone FIRE Alarm Indicator - flashing



Common FIRE Alarm Indicator – flashing



2. To Silence the FACP Buzzer

Press  

3. To Silence External Sounders Enter Access Level 2 – Key in Password - 3, 2, 1, 0

Press  

CONTROLS ENABLED indicator - steady



and

4. Indicators

Zone FIRE Alarm indicator – steady



Common FIRE Alarm indicator – steady



REMOTE OUTPUT ON indicator – steady

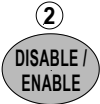

Disabling the Alarm Zone/s

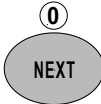
1. Enter access Level 2

Press   Zone 1 Selected. Press   to select Zone in FIRE

Then   to Disable

2. To Disable Zone FIRE Alarm

3. Indicators

Zone **DISABLED** Indicator – flashing then steady



Common **DISABLED** Indicator – flashing then steady

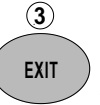

Press   to EXIT the ENABLE / DISABLE mode and Access Level 2

4. Indicators - Zone **DISABLED** Indicator –steady

Common **DISABLED** Indicator –steady



CONTROLS ENABLED Indicator – off



Resetting the Panel

Press   RESETS FACP (ZONE ALARM)

Note: Audible feedback will be given for each button press.

TABLE OF CONTENTS

Page No.

1	About This Manual	1
1.1	Purpose	1
1.2	Scope.....	1
1.3	References.....	1
1.4	Symbols	1
2	Introduction	2
3	Mechanical	3
3.1	Locating the FACP	3
3.2	PCB Removal / Replacement	3
3.3	Removing the Knockouts.....	3
3.4	Fixing the Chassis to the Wall.....	4
4	Electrical	6
4.1	Introduction	6
4.2	Mains wiring	6
4.3	Connecting the Mains.....	6
4.4	Cable Types and Limitations.....	6
5	Power Supply	7
5.1	Primary Power Supply	7
5.2	Standby Power Supply	7
5.2.1	Setting Battery Monitoring.....	7
5.3	Power Faults	7
5.4	Power Management	8
5.5	Powering Up and Down Sequence – Batteries Fitted	8
6	Connecting to and Operation of the Main Control Board	9
6.1	Optional Key Switch	9
6.2	Communications (TB400 / CN400)	9
6.3	Inputs (TB1)	9
6.4	Zone Circuits (TB2 & TB800).....	10
6.4.1	Operating Conditions	10
6.4.2	Detector Removal Facility	11
6.5	Outputs – Monitored Alarm Outputs (TB3, TB801).....	11
6.6	Outputs – Open Collector (TB4).....	12
6.7	Remote Output – (TB4/1)	12
6.8	Fault Output – (TB4/2).....	12
6.9	Ancillary Output – (TB4/3)	12
6.10	Reset – (TB4/4).....	12
6.11	Auxiliary Power Output – (TB4/5).....	12
6.12	Outputs – Volt Free Relay (TB5).....	12
6.12.1	Remote Output Relay	12
6.12.2	Fault Output Relay.....	13
6.13	Watchdog Circuitry	13
6.14	Checksum	13
6.15	Enabling and Setting Delay Timing	14
6.16	Setting the Zone Configuration DIP Switches.....	14
6.17	Summary of Main Card Terminations.....	15
7	FACP Front Panel Controls and Indicators	16
7.1	Access Levels and Passwords	16
8	Ancillary Modules	18
8.1	Programming Ancillary Modules	18
8.2	8 Way Relay Board	18
8.3	LED Annunciator Master (LAM) Card.....	19
8.4	Summary of Typical Ancillary Board Specifications	20
9	Configuration	21
10	Compatible Devices	22

11	Calculating Standby Battery Capacity.....	23
12	Trouble Shooting.....	24
13	Definitions	26
14	Glossary of Terms.....	27
15	Specifications.....	28

1 About This Manual

1.1 Purpose

This manual is an instructional tool for the installation, commissioning, programming / reprogramming and operation of the **ZoneSense** Fire Alarm Control Panel (FACP).

1.2 Scope

The **ZoneSense** FACP has been designed and manufactured from high quality commercial components so as to comply with major world standards. To ensure these standards are not compromised in any way installation staff and operators should;

- Be qualified and trained for the task they undertake;
- Be familiar with the contents of this manual prior to the installation, commissioning or operation of a FireFinder control system;
- Observe anti-static pre-cautions at all times; and
- Be aware that if a problem is encountered or there is any doubt with respect to the operational parameters of the installation the supplier should be contacted.

1.3 References

This manual explains how to install and commission the **ZoneSense** FACP and should be read in conjunction with User's Manual and Log Book that accompanies the panel.

Documents related to the design, manufacture and installation of the **ZoneSense** FACP are;

- EN54 Pt 2 Fire detection and fire alarm systems - Control and Indicating Equipment
- EN54 Pt 4 Fire detection and fire alarm systems - Power Supply Equipment
- BS 5839 – 1: 2002 Fire detection and alarm systems for buildings
- Code of practice for system design, installation and servicing.

1.4 Symbols



Important operational information



Note: Configuration considerations



Observe antistatic precautions



Mains supply earth



DANGER mains supply present

2 Introduction

The **ZoneSense** Fire Alarm Control Panel (FACP) is supplied in an ABS (with a surround for recessed mounting) or metal cabinet as a two, four or eight zone Conventional FACP and can have up to four (4) remote LED Annunciator Cards (LAM's) Order Code 43100-0037 and / or one (1) 8 Way Relay Board Order Code 4310-0050 [internal] 4310-0055 [external].

ZoneSense meets the EN54-2 and EN54-4 standards, complies with the optional clauses 7.8 (Output to fire alarm devices), 7.11 (Delays to outputs) 10 (Test condition) and offers limited on site programming and operational test facilities.

Features include;

- Controls that have tactile and audible feedback of operation.
- On-site programming.
- Terminals cater for up to 2.5mm diameter cables.

Buzzer Operation

The buzzer provides audible:

- Indication at system start-up (3 tone bursts of increasing frequency)
- Indication of a fire condition. Tone is continuous, until the buzzer is silenced or the fire condition is cleared by reset.
- Indication of a fault condition. Tone is 1 second on, 1 second off, until the fault condition clears.
- Feedback when a key is pressed.
- Feedback when multiple keys are pressed simultaneously or illegal key press (for example RESET when at access level 1) or there is a timeout condition entering the password.

The buzzer:

- Is silenced by SILENCE BUZZER but will resound on any new alarm or fault condition.
- Sounds during a lamp test.
- Sounds (fault indication), when the power supply is not calibrated.
- Sounds when calibration is successful (same tone bursts as at system start-up)

3 Mechanical

The **ZoneSense** FACP has an ABS (BX1) or Metal (BX10) enclosure that meets IEC529:1989 IP30 classification. The enclosure houses the Main Control Board (which has all the controls / indicators, power supply / battery charger circuitry mounted directly onto it), mains transformer and batteries. All can be easily removed to allow the cabinet assembly to be fixed to the building structure without obstruction.

3.1 Locating the FACP

The FACP MUST be installed in an area that is NOT subject to conditions likely to affect its performance e.g. damp, salt-air, water ingress, extremes of temperature, physical abuse, etc.

It should be:

- At eye height;
- Easily accessible; and
- In a prominent position within a building. Typical locations are the first and most obvious point of contact for emergency services, e.g.; an entrance foyer; the hallway of a building at ground floor level; or a security situation that is likely to be permanently monitored.

3.2 PCB Removal / Replacement

If the PCB has to be removed the following precautions must be observed;

- Removing the door will provide better access to the board/s and ensure the hinges are not accidentally stressed. To remove swing the door open and push upwards at the hinges as indicated in the following assembly drawing.
- 
- Personal anti- static procedures must be followed.
 - Disconnect all wiring; carefully remove the retaining screws at each corner of the bridge all the while taking care not to damage any of the components.
 - Place the bridge into an anti - static storage once removed.

3.3 Removing the Knockouts

Carefully decide how the wiring will be brought into the panel then remove the required knock-outs for the bushes and cabling.

The knock-outs should be removed with a series of sharp taps around the rim of the knock-out impression using a flat broad-bladed screwdriver.

Exercise some care during this process as the use of excessive force could damage the enclosure around the knock-out.

If a knock-out is removed always ensure, the hole is filled with a good quality cable gland. Any unused knock-outs must be securely blanked off.



Figure 1: Removing Knockout

3.4 Fixing the Chassis to the Wall

Refer to the diagrams of the panel showing a *Typical FACP Layout*.

If necessary remove the batteries to expose the lower mounting keyhole.

Taking into account the total weight of the panel securely mount it by using the three keyhole mounting holes using suitably sized screws and plugs for the type of mounting surface while at the same time ensuring any dust or swarf created during the fixing process is kept out of the panel

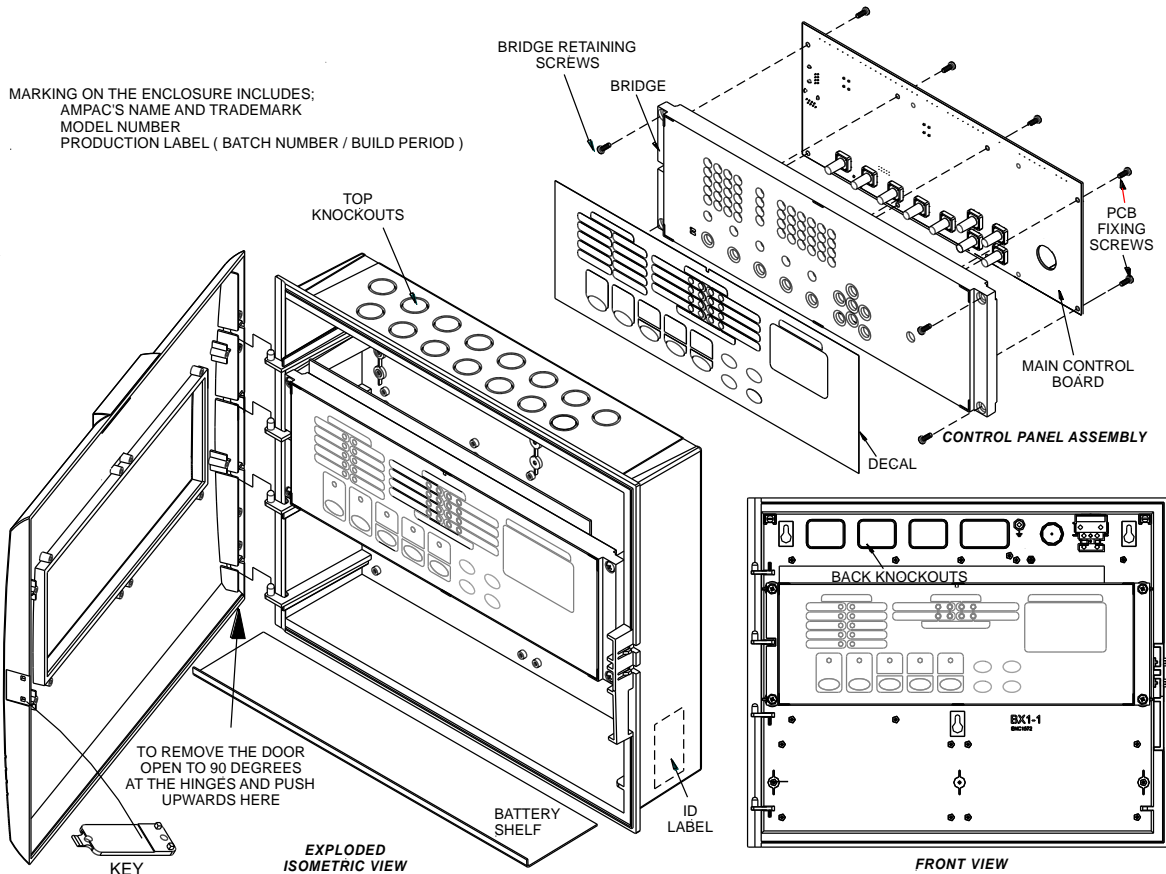

Figure 2: Exploded Views of ABS (BX1) Cabinet, Decal, Bridge and PCB Note: The Metal (BX10) cabinet is assembled in the same fashion

The BX1 front door is locked by way of two clips on the right hand side of the cabinet. A special locating key which has two raised pins that are inserted into the side of the cabinet unlocks the door. The BX1 can also be supplied with a 003 Key Lock if required. The BX10 box is locked with a 003 Key.

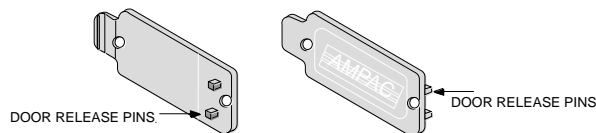

Figure 3: Plastic Key

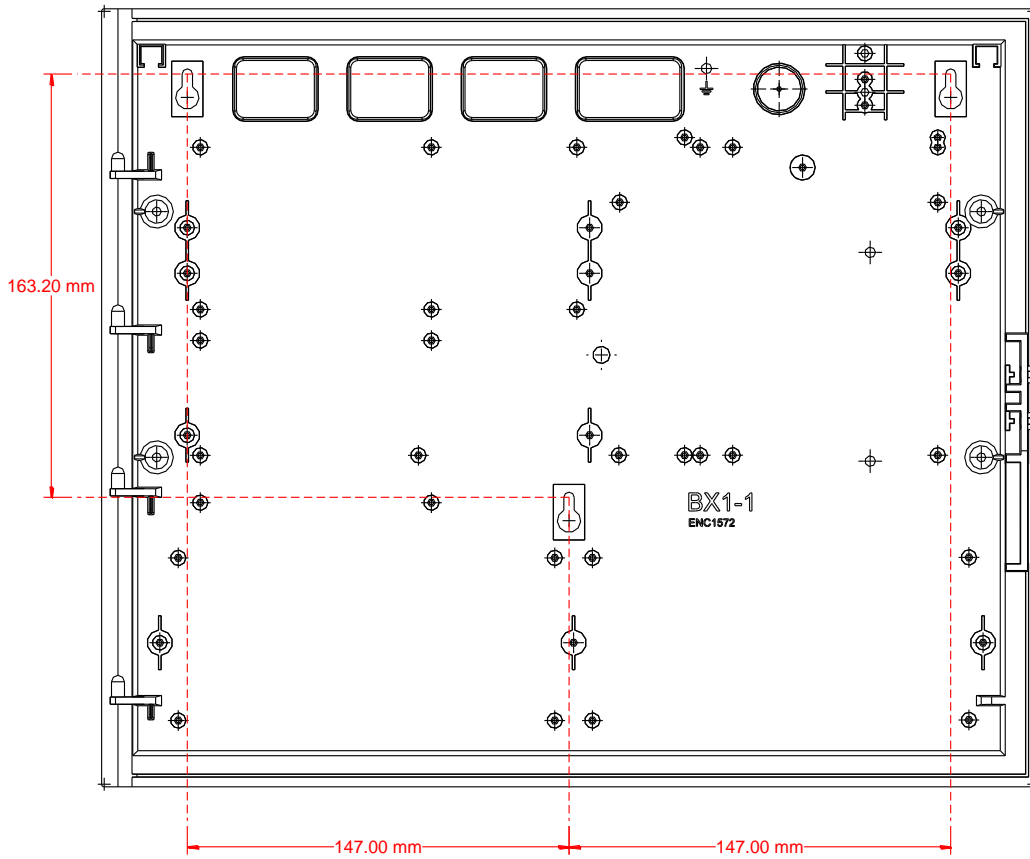

Figure 4: ABS (BX1) Mounting Points

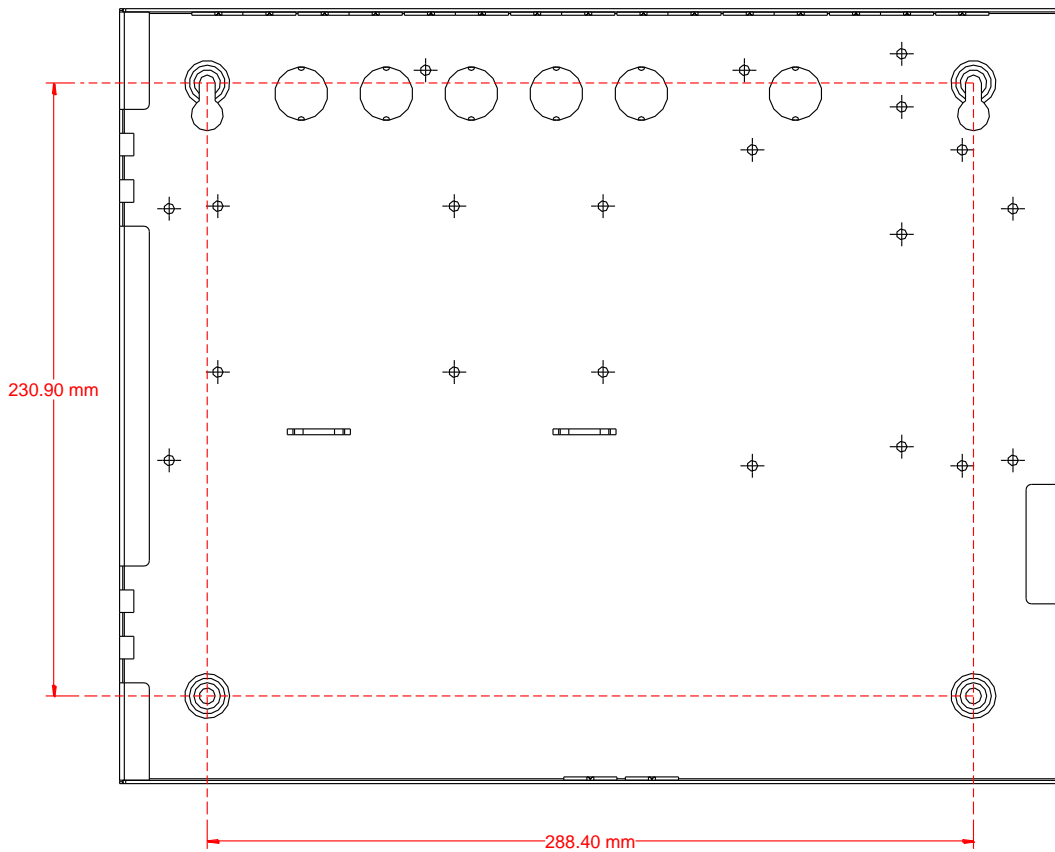

Figure 5: Metal Cabinet (BX10) Mounting Points

4 Electrical

4.1 Introduction

The FACP consists of the Main Control Card and mains transformer. The control board is broken into two sections, the main control circuitry and the power supply / charger.

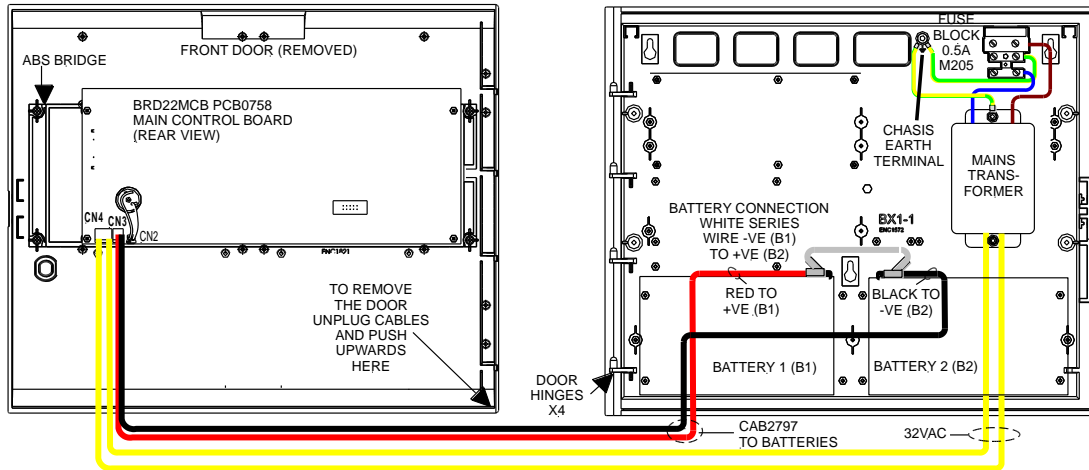

Figure 6: Battery Connection & General Wiring Diagram

4.2 Mains wiring

The requirement for the 'Mains' supply to the Fire Alarm Control Panel is three core cable (no less than 1mm" and no more than 2.5mm") fed from a fused 3A isolating switched spur which should be secured from unauthorised operation and be marked 'FIRE ALARM: DO NOT SWITCH OFF'.

4.3 Connecting the Mains

The incoming Mains cable should be brought into the Panel at the top right hand side of the enclosure and correctly terminated to the fuse / terminal block. Wired to this terminal block is the mains transformer that reduces the mains to the required 32VAC secondary voltage.

Before switching on the Power Supply the Earth MUST be connected to the chasis earth terminal as shown in the following diagram.

- All earth cabling must be terminated to the Panels Chassis Earth Terminal in a Star configuration.
- Each additional earth cable must be terminated with an M4 nut and M4 washer.
- An additional M4 nut and washer are fitted to the earth terminal for installers to connect their mains earth

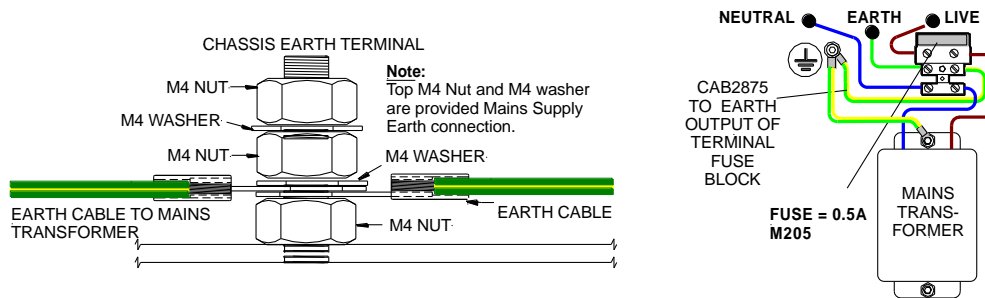

Figure 7: Chassis Earth Terminal Connection

4.4 Cable Types and Limitations

All System wiring should be installed to meet Wiring Regulations. Other National standards of installation should be used where applicable.

To shield the Panel from outside interference and ensure compliance with Electro Magnetic regulations screened cables can be used throughout an installation.

5 Power Supply

The power supply equipment (PSE) consists of a primary power supply and battery standby if required.

The primary power supply derives the appropriate voltages to run the FACP and charge the batteries (if fitted) from the available mains supply. In the event of a failure of the mains supply the PSE automatically switches over to the standby rechargeable sealed lead acid batteries to power the FACP. During this time the FACP will indicate there is a power fault (Power Fault LED flashes) and continue to function normally. When the mains is restored the PSE automatically switches back to the primary power source. If the mains interruption is of such duration that the standby battery capacity is reduced to such a level as dictated by the battery manufacturer the FACP will shut down.

The maximum size batteries that can be accommodated within the enclosure are 7A/Hr.

5.1 Primary Power Supply

The primary power supply operates from 204 to 265VAC, is capable of producing a nominal 24VDC at up to 1.6 amps. It consists of a transformer mounted to the rear of the enclosure and appropriate circuitry located on the control card.

A DC to DC converter converts the 24VDC to 3.3VDC to power the FACP microprocessor.

5.2 Standby Power Supply

The optional backup battery supply is required to be able to maintain FACP quiescent operation for 24 hours (72 for non monitored applications) in the event of mains power failure, then supply full alarm load for a period of 30 minutes.

The standby power supply has a low voltage disconnect to prevent the batteries from being discharged below 21VDC.

Requirements of the battery charger are to:

- Ensure the batteries are charged according to the manufacturers specifications.
- To provide a facility to measure the battery voltage, and detect a missing or damaged battery
- To provide a facility to turn off the charger output.
- To provide a facility to measure the charger voltage
- To ensure the battery connection is protected against reverse or short circuit connection
- To ensure the battery does not discharge through the battery charger, when the charging voltage is less than the battery voltage.

5.2.1 Setting Battery Monitoring

If the optional backup battery supply is not fitted to the FACP the battery monitoring is disabled (at access level 3) by using switch 1 of the 4 way DIP switch SW10. Switch is ON to enable monitoring, and OFF to disable monitoring.

5.3 Power Faults

Power faults are detected within 10 seconds and displayed by the FACP. Faults detected are;

- Loss of mains *and if batteries are fitted and monitoring enabled.*
- Missing or damaged batteries
- Battery voltage below 21.6V
- Charger voltage in excess of 28.8VDC
- Loss of charger voltage

5.4 Power Management

The following is the current requirements of the panel.

Requirement	Current
Battery Charger	234mA
8 x Zones @ 25mA (in alarm)	200mA
8 x Zones @ 2mA (normal)	16mA
4 x Monitored Outputs (250mA each)	1000mA
24VDC Common for O/C outputs	170mA
Aux 24VDC	150mA
FACP electronics	20mA

In the quiescent state, current requirements are:

Requirement	Current
Battery Charger (assume max charge)	234mA
8 x Zones @ 2mA (normal)	16mA
Aux 24VDC	150mA
FACP electronics	20mA
Total	425mA

i **Note:** For a 2 zone panel, the zone current requirement is 4mA, making a total of 413mA, and is 8mA or 417mA for a 4 zone panel.

In the alarm state current requirements are; (assume all 8 zones in alarm, and charger disabled)

Requirement	Current
8 x Zones @ 25mA (in alarm)	200mA
4 x Monitored Outputs (250mA each)	1000mA
24VDC Common for O/C outputs	170mA
Aux 24VDC	150mA
FACP electronics	20mA
Total	1545mA

For the 2 zone panel, 50mA is required for the zones, 500mA for the monitored outputs (2 fitted) plus the normal operational current totals 895mA.

For the 4 zone panel, 100mA is required for the zones, and 500mA for the monitored outputs (2 fitted), plus the normal operational current totals 945mA.

5.5 Powering Up and Down Sequence – Batteries Fitted

Given the current involved on “power up” the following procedure **MUST** be followed;

Power Up

- Connect the batteries – white cable +ve red terminal to black terminal –ve (places the batteries in series) red cable to red + ve terminal, black cable to –ve black terminal.
- Switch on the mains supply

Power Down

Switch off the mains supply

Remove the positive (+ve) lead from the batteries

i **Note:** After a “Power Down” the mains supply and batteries **MUST** be left disconnected for at least 1 minute to allow any residual capacitive charge to be dissipated. If this process is not followed a SYSTEM FAULT could be incorrectly indicated

6 Connecting to and Operation of the Main Control Board

The Main Control Board provides a range of different field terminations – inputs, zone circuits, monitored outputs, voltage free outputs (relay), communications, open collector outputs and can include an optional controls enable front panel mounted key-switch.

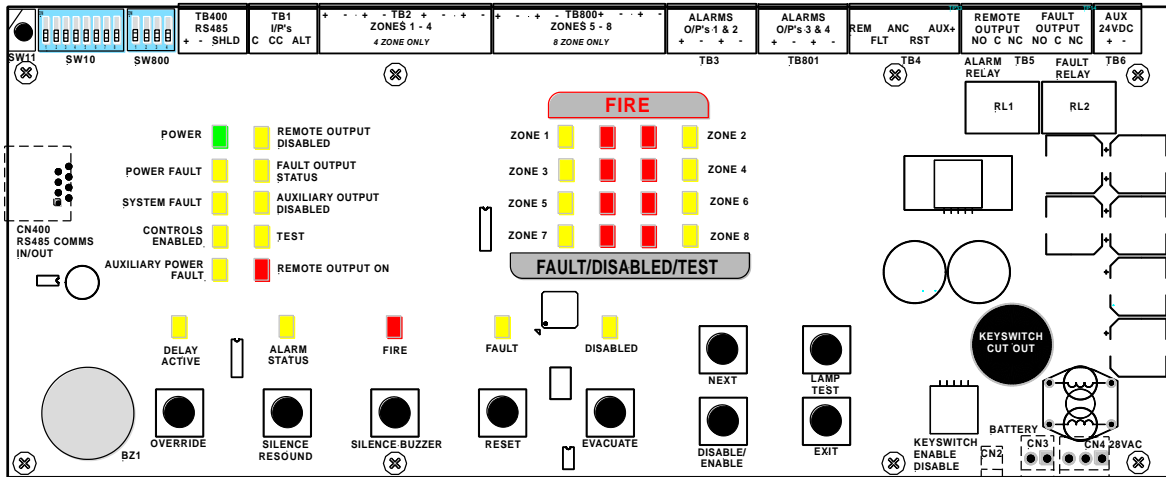

Figure 8: Main Board Layout

6.1 Optional Key Switch

The keyswitch is optional and if fitted provides keyed level 2 access.

6.2 Communications (TB400 / CN400)

RS485 communications allows the Main Control Board to communicate with the internal and / or external ancillary boards but is only fitted to the 4 and 8 zone FACP's.

The external communication are protected to meet the relevant standards, consists of three terminals, A, B & Shield and drives a maximum of four (4) LAM's and one (1) 8 Way Relay Board.

Note: Terminal block (communications) is only fitted to the 4 and 8 zone FACP's

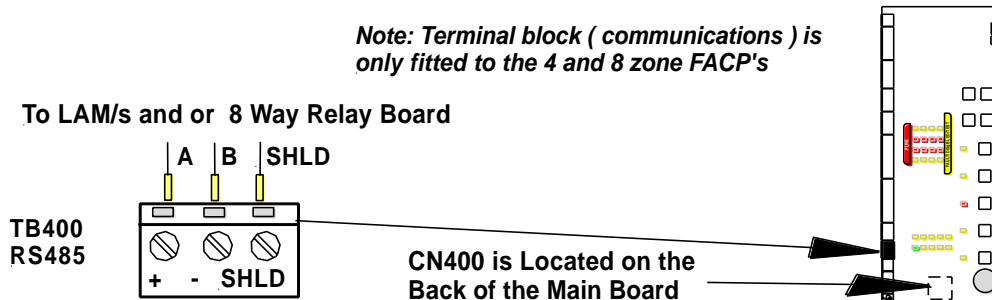

Figure 9: TB400 Termination & Location on the Main Control Card

6.3 Inputs (TB1)

Common Terminal

Used for inputs requiring a 0V potential to initiate a change of state in an output.

Class Change Input

This input allows a remote voltage free, closing set of contacts to operate the Alarm outputs. The non-latching input is active when it is pulled down to 0v potential. When active the Alarm Outputs will operate continuously, no visual indication is given and no other output shall operate.

Alert Input

This non-latching input allows a remote voltage free, closing set of contacts to operate the Alarm outputs. The input is active when it is pulled down to 0v potential. When active the Alarm Outputs will pulse at a rate of 1sec on 1 sec off, no visual indication is given and no other output will operate.

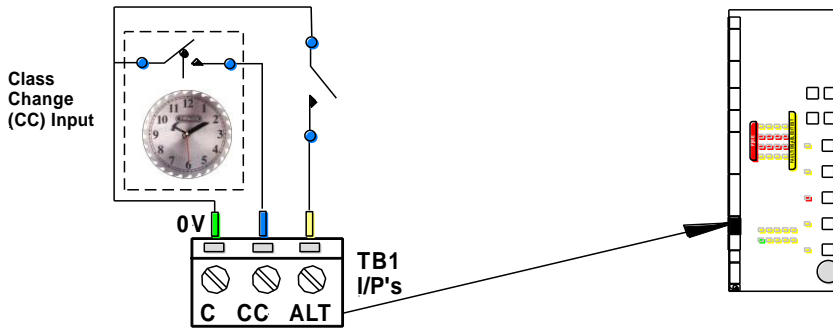

Figure 10: TB1 Typical Class Change / Alert Input Termination & Location on the Main Control Card

6.4 Zone Circuits (TB2 & TB800)

A maximum of 32 x 24volt Optical / Heat Detectors and / or Manual Call Points mixed in any order can be fitted to each circuit. An output current of 4mA for each circuit with capacitive EOL is considered to normal and in a worst case or fault S/C condition each circuit is current limited to a maximum of 25mA.

The Main Control Board has up to eight (8) zone circuits that connect to the 24VDC conventional fire detectors. The maximum number of detectors and MCP's that can be supported will be influenced by the quiescent current draw of the detectors and MCP's being fitted.

The wiring for each zone circuit should be connected to the relevant terminal block on the Main Control PCB and if screened the screens terminated at the panel's base earth post.

An End of Line 10µF Bi-polar Capacitor must be connected across the terminals of the last device on each circuit to allow the circuit to be monitored. Zones that are not used must also have an End of Line capacitor fitted to the terminal block at the panel.

The detector interface is compatible with Apollo and Hochiki conventional detectors (refer to the list of compatible devices). Reset time is 2 seconds. Each zone circuit will function as follows.

Reported Condition	Comment
Disable	When the zone circuit has been disabled.
Fault	Short circuit exists on the zone circuit
Alarm	One or more detectors have been activated
Fault	EOL capacitor is not detected (O/C condition), detector removed
Normal	All detectors are normal and EOL capacitor is connected

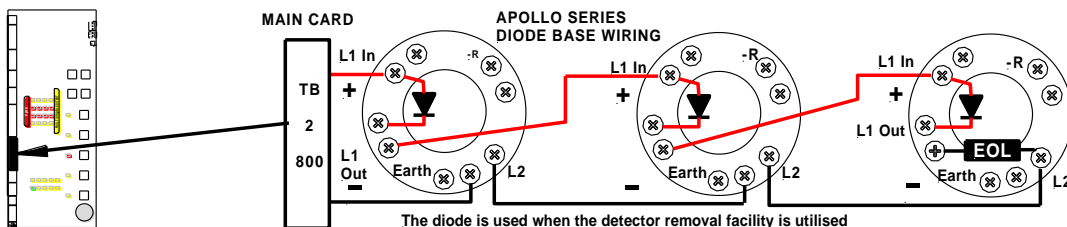

Figure 11: TB2 / 800 Detector Wiring & Location on the Main Control Card

6.4.1 Operating Conditions

All zone fault conditions are non-latching hence cleared when the reset control is activated, and are re-announced within 10 seconds if the fault condition still exists.

Zone alarms are only configured as latching. This means that irrespective of the condition of the zone itself the alarm condition can only be cleared when the front panel reset control is activated,

Zones can also be configured to have an associated output delay timer. The delay time can be set from 30 seconds up to 7 minutes and 30 seconds. If the zone is configured with a delay then the activation of the alarm outputs and ancillary output is delayed accordingly. A front panel control is provided to override the delay. This is associated with an indicator which is illuminated when the delay timer is active.

Note: The activation of the remote output relay is not affected by the delay timer.

Typically MCP's must be fitted with series resistors (470 or 680 ohm), so as when the MCP is activated a short circuit is not present on the zone circuit.

The zone circuits can be disabled by using the front panel controls Once disabled, the zones do not cause the activation of the alarm outputs, remote relay output or ancillary output.

6.4.2 Detector Removal Facility

This facility allows for up to 20 detectors to be removed from their bases at any one time. If a detector head is removed a fault will be indicated on that zone and all the other devices retain the ability to initiate an alarm. This facility requires a Schottky diode to be fitted as per Figure 11

Note: Schottky diodes having a voltage drop of 0.2 – 0.3 of a volt have to be installed across L1 in and L1 out on the detector base. The limitation on the number of heads that can be removed is a direct result of the cumulative effect of the voltage drop across each diode.

Diodes will not be required if the head removal facility is not required.

6.5 Outputs – Monitored Alarm Outputs (TB3, TB801)

The Main Control Card has four (4) parallel PTC protected monitored outputs typically used to power electronic type sounders and are referred to as alarm outputs. Each output is nominally rated at 250mA @ 24VDC and monitored for open and short circuit conditions when the output is not activated.

Monitoring is achieved by the sensing of the End of Line (EOL) 10kΩ resistors and is independent of the loading of bells and sounders. The monitoring is forward biased and requires diodes to be fitted in series with each bell and sounder. Faults on the monitored outputs will be indicated by the FACP within 60sec.

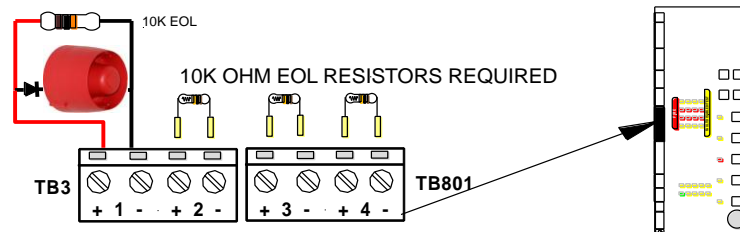

Figure 12: TB3 – TB801 Termination Block with Sounder fitted & Location on the Main Control Card

Note: The 2 zone and 4 zone version has 2 alarm outputs fitted while the 8 zone version has 4 alarm outputs fitted.

The alarm outputs are activated by the:

- Class change input
- Alert input
- Front panel evacuate control, silence/resound control
- Zones entering the alarm condition. If there are no delays programmed the alarm outputs will be activated within 3 seconds of the zone entering the alarm condition.

General Conditions

Zones entering the alarm condition will always activate the alarm outputs. Alarm outputs can be de-activated by the silence/resound control and/or a reset of the zone(s) in alarm.

The front panel Evacuate control will always activate the alarm outputs. Alarm outputs can be de-activated by the silence/resound control and/or a reset

If the Class Change input is ON and there are no zones in alarm and the front panel evacuate control is not active, then the alarm outputs will be activated.

If the Alert input is ON, Class Change input is OFF, there are no zones in alarm and the front panel evacuate control is not active then the alarm outputs will pulse at the rate of 1sec ON and sec OFF.

The Alarm outputs can be disabled by using the front panel control. Once disabled, the outputs will remain off until they are re-enabled. A front panel indicator associated with the output is illuminated when these outputs are disabled.

6.6 Outputs – Open Collector (TB4)

There are four unmonitored open collector type outputs. Each output is capable of switching 40mA of output current and withstand a short circuit condition to the common +24VDC output without damage.

Note: The common +24VDC feed is current limited to 170ma by a PTC and monitored at the terminal block. If there is an over current situation, then the PTC will activate and a fault will be reported at the FACP

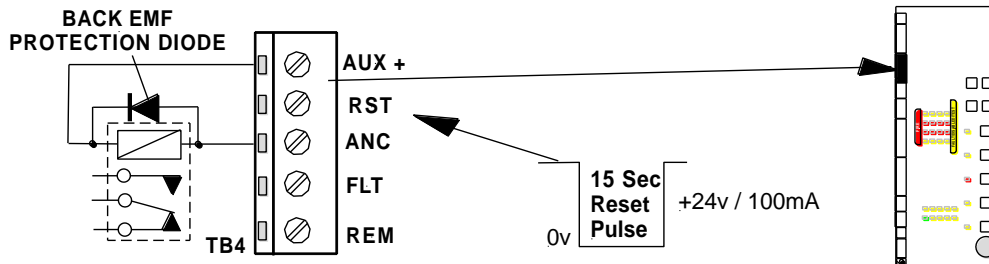

Figure 13: TB4 Remote, Fault, Ancillary Reset, Auxiliary Output Terminations, Reset Pulse & Location on the Main Control Card

6.7 Remote Output – (TB4/1)

The operation of this output is identical to the operation of the remote output relay.

6.8 Fault Output – (TB4/2)

The operation of this output is identical to the operation of the fault output relay.

Note: This output will be normally energised, and de-energised to signify a fault condition.

6.9 Ancillary Output – (TB4/3)

Ancillary Output is a un-monitored open collector output activated when any of the zones report an alarm condition. The activation of this output is subject to any delays that may be configured.

This output can be disabled by using the front panel controls. Once disabled the output will remain off until it is re-enabled. The ANCILLARY OUPUT front panel indicator is illuminated when this output is disabled.

6.10 Reset – (TB4/4)

Reset is a non-monitored open collector output activated for 15sec with the FACP reset.

6.11 Auxiliary Power Output – (TB4/5)

This +24VDC output with an associated return is monitored at the terminal block and current limited to 150mA @ 24VDC by a PTC. If an over current situation occurs fault will be indicated.

6.12 Outputs – Volt Free Relay (TB5)

There are two voltage free relay outputs, the Remote output, and the Fault output.

6.12.1 Remote Output Relay

The Remote Output Relay has 1A 30VDC unmonitored voltage free single change over contacts that are activated when any zone circuit reports an alarm condition. The front panel indicator “Remote Output On” is illuminated when the output is activated and is reset via the front panel reset control.

The output can also be disabled by using the front panel controls. Once disabled the relay will remain off until re-enabled and the front panel indicator “Remote Output Disabled” is illuminated.

6.12.2 Fault Output Relay

The Fault Output Relay is energised if the FACP is operating normally and has unmonitored 1A 30VDC voltage free single change over contacts. The output can be disabled by using the front panel control. Once disabled the relay will remain on until it is re-enabled and the FAULT OUTPUT front panel indicator is illuminated when this output is disabled.

If a fault is present on the FACP the output relay is de-energised and remains de-energised until the fault conditions have cleared. There are a number of front panel fault indicators that detail the nature of the fault. These are:

- Power Fault – fault relating to the power supply.
- System Fault – fault relating to the operation of the FACP.
- Auxiliary Power Fault – fault relating to the auxiliary power output. Individual zone fault indicators.
- Alarm Outputs.
- Faults associated with ancillary modules – missing, type mismatch or extra.

Note: #1: All faults are non-latching, except for system fault.

Note: #2: Faults associated with zones are cleared on a reset condition.

Note: #3: Power faults are indicated

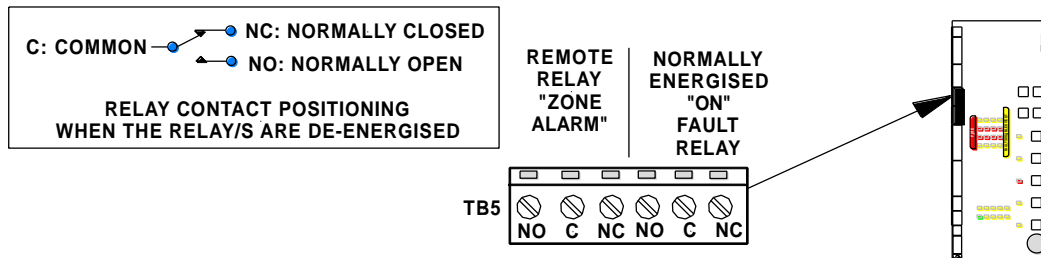

Figure 14: TB5 Remote and Fault Relay Termination & Location on the Main Control Card

6.13 Watchdog Circuitry

The Main Control Board has watchdog circuitry external to the main processor that strobes the main processor at intervals equal to or less than 1 second. If the 1 second interval is not met the main processor is reset by the Watchdog circuitry, the system fault and common fault indicators will be illuminated and the buzzer will sound. These indicators remain illuminated until reset.

If the main processor fails to successfully restart after six to twelve reset operations the processor is held in reset. In the situation where the processor is held in reset, the buzzer will sound, the system fault and fault indicators will flash at 0.25Hz, that is On for 2 seconds and Off for 2 seconds.

6.14 Checksum

At periods not exceeding one hour, the main processor performs a checksum operation on the application software and configuration data. If the application software or configuration data has become corrupted then the main processor enters the reset state, the buzzer will sound, and the system fault / fault indicators will flash at 0.25Hz, that is On for 2 seconds and Off for 2 seconds.

6.15 Enabling and Setting Delay Timing

 **Note:** Delay enabling and timing can only be set at access level 3

Enabling

An 8 way DIP switch is used to enable the delays on a zone by zone basis. Switch 1 corresponds to zone 1; Switch 2 corresponds to zone 2 and so on.

Switch OFF position disables delay, and the ON position enables delay. For example if switch 1 is OFF, and switch 2 is ON, then zone 1 has delays disabled, and zone 2 has delays enabled.

Setting the Delay Time

If delays are enabled the delay time is the same for all zones. The length of the delay is set by adjusting the 4 way DIP switch, adjustable from 0 to 8:00 minutes in steps of 30 seconds,

DIP SWITCH SETTINGS				Delay Value in Min: Sec
1	2	3	4	
OFF	OFF	OFF	OFF	0:30
ON	OFF	OFF	OFF	1:00
OFF	ON	OFF	OFF	1:30
ON	ON	OFF	OFF	2:00
OFF	OFF	ON	OFF	2:30
ON	OFF	ON	OFF	3:00
OFF	ON	ON	OFF	3:30
ON	ON	ON	OFF	4:00
OFF	OFF	OFF	ON	4:30
ON	OFF	OFF	ON	5:00
OFF	ON	OFF	ON	5:30
ON	ON	OFF	ON	6:00
OFF	OFF	ON	ON	6:30
ON	OFF	ON	ON	7:00
OFF	ON	ON	ON	7:30
ON	ON	ON	ON	8:00

6.16 Setting the Zone Configuration DIP Switches

 **Note:** Zone configuration can only be set at access level 3

In the **2 zone** version one 8 way DIP switch is fitted, switches 1 - 4 are used for setting the delay time, switch 5 enables the delays for zone 1, and switch 6 enables the delays for zone 2.

The **4 zone** version is the same as the 2 zone version, with the addition that switch 7 enables the delays for zone 3 and switch 8 enables the delays for zone 8.

In the **8 zone** version an 8 way DIP switch and a 4 way DIP switch are fitted. The 8 way DIP switch is used the same as the 4 zone version. Switch 1 of the 4 way DIP switch enables the delays for zone 5; switch 2 enables the delays for zone 6; switch 3 enables the delays for zone 7; and switch 4 enables the delays for zone 8

Switch Type	Switch	Function
8 Way (always fitted)	1,2,3,4	Delay time
	5	Zone 1 Delay (all models)
	6	Zone 2 Delay (all models)
	7	Zone 3 Delay (4 and 8 zone model only)
	8	Zone 4 Delay (4 and 8 zone model only)
4 Way (only fitted on the 8 zone version)	1	Zone 5 Delay (8 zone model only)
	2	Zone 6 Delay (8 zone model only)
	3	Zone 7 Delay (8 zone model only)
	4	Zone 8 Delay (8 zone model only)

6.17 Summary of Main Card Terminations

Terminal Number	Terminal Description	Terminal Operation/Build Option
COMMUNICATIONS EXTERNAL		
TB400 / 1	RS485	Used to connect to one 8 way relay card and up to four LAM's
2	RS485	
3	Shield	
INPUTS		
TB1 / 1	Common	Fitted on all models
2	Class Change (Steady alarm out)	
3	Alert (Pulsing alarm output)	
ZONES		
TB2 / 1	+ Zone 1	Zone Circuits 1 and 2 Fitted on all models
2	- Zone 1	
3	+ Zone 2	
4	- Zone 2	
5	+ Zone 3	Zone Circuits 3 and 4
6	- Zone 3	
7	+ Zone 4	Fitted on the 4 and 8 zone models
8	- Zone 4	
TB800 / 1	+ Zone 5	Zone Circuits 5, 6, 7 and 8 Fitted on the 8 zone model
2	- Zone 5	
3	+ Zone 6	
4	- Zone 6	
5	+ Zone 7	
6	- Zone 7	
7	+ Zone 8	
8	- Zone 8	
MONITORED OUTPUTS		
TB3 / 1	Alarms 1 + 250mA	Alarm outputs 1 and 2 Fitted on all models
2	Alarms 1 – 250mA	
3	Alarms 2 +250mA	
4	Alarms 2 – 250mA	
TB801 / 1	Alarms 3 +250mA	Alarm outputs 3 and 4 Fitted on the 8 zone model
2	Alarms 3 – 250mA	
3	Alarms 4 +250mA	
4	Alarms 4 – 250mA	
OPEN COLLECTOR OUTPUTS		
TB4 / 1	Remote Output (40mA)	Fitted on all models
2	Fault Output (40mA)	Fitted on all models
3	Ancillary Output (40mA)	Fitted on all models
4	Reset Output (40mA)	Fitted on all models
5	24VDC + Com for O/C outputs	Current limited to 170mA
OUTPUTS VOLT FREE RELAY (1A @ 24VDC)		
TB5 / 1	NO Remote Output	Fitted on all models
2	C Remote Output	
3	NC Remote Output	
4	NO Fault	Fitted on all models
5	C Fault	
6	NC Fault	
TB6 / 1	Aux 24VDC + (Mon 150mA)	Fitted on all models. Current limited to 150mA
2	Aux 24VDC -	
AC INPUT FROM MAINS TRANSFORMER		
CN4 / 1	V~	Fitted on all models
2	V~	
3	Earth	
CONTROLS ENABLED KEYSWITCH		
CN2 / 1	Common	Input from optional key-switch
2	Controls Enabled	
8	24VDC	

7 FACP Front Panel Controls and Indicators

The front panel consists of a 9 push buttons and 31 LED indicators, and an optional key-switch.

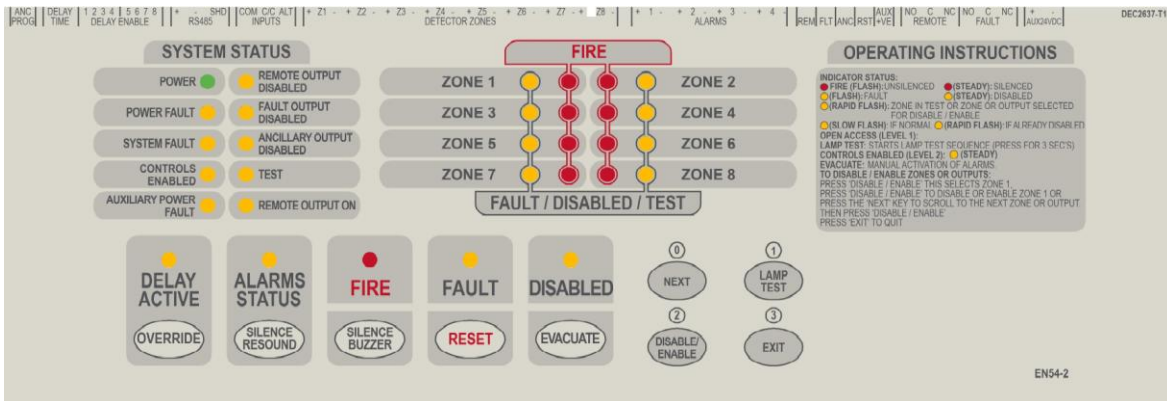

7.1 Access Levels and Passwords

By default the FACP is in access level 1.

Entry to access level 2 can be gained in two ways.

entering a fixed digit password (3210);

The password is entered by depressing the Exit ③ key, then the Enable/Disable ② key, then the Lamp Test ①, and finally the Next ① key. The timing between key presses must be 10 seconds or less. If the timing between key presses is greater than 10 seconds, then the password must be re-entered. The timeout is accompanied by an error beep from the buzzer.

Note: If the FACP is in access level 2 (by entering the password), and no controls are operated within 120 seconds, then the FACP will revert to access level 1. This is to ensure that there is no unauthorised operation.

via the optionally fitted controls enabled key-switch.

All Control Enable key switches fitted to the FACP's are keyed alike. The key is only remove-able in the off or disabled position.

Operating the key switch will put the FACP into access level 2, and the Controls Enabled indicator will be illuminated steady.

Provision is made on the main card to interface to the controls enabled key switch. If the key switch is not fitted, then the interface defaults to the "off" setting.

Entry to access level 3 is by opening the front panel door of the FACP using a special tool. Once the door is opened, access can be gained to the level 3 access / programming push button and DIP switches located in the top left hand corner of the main board (see over for board layout).



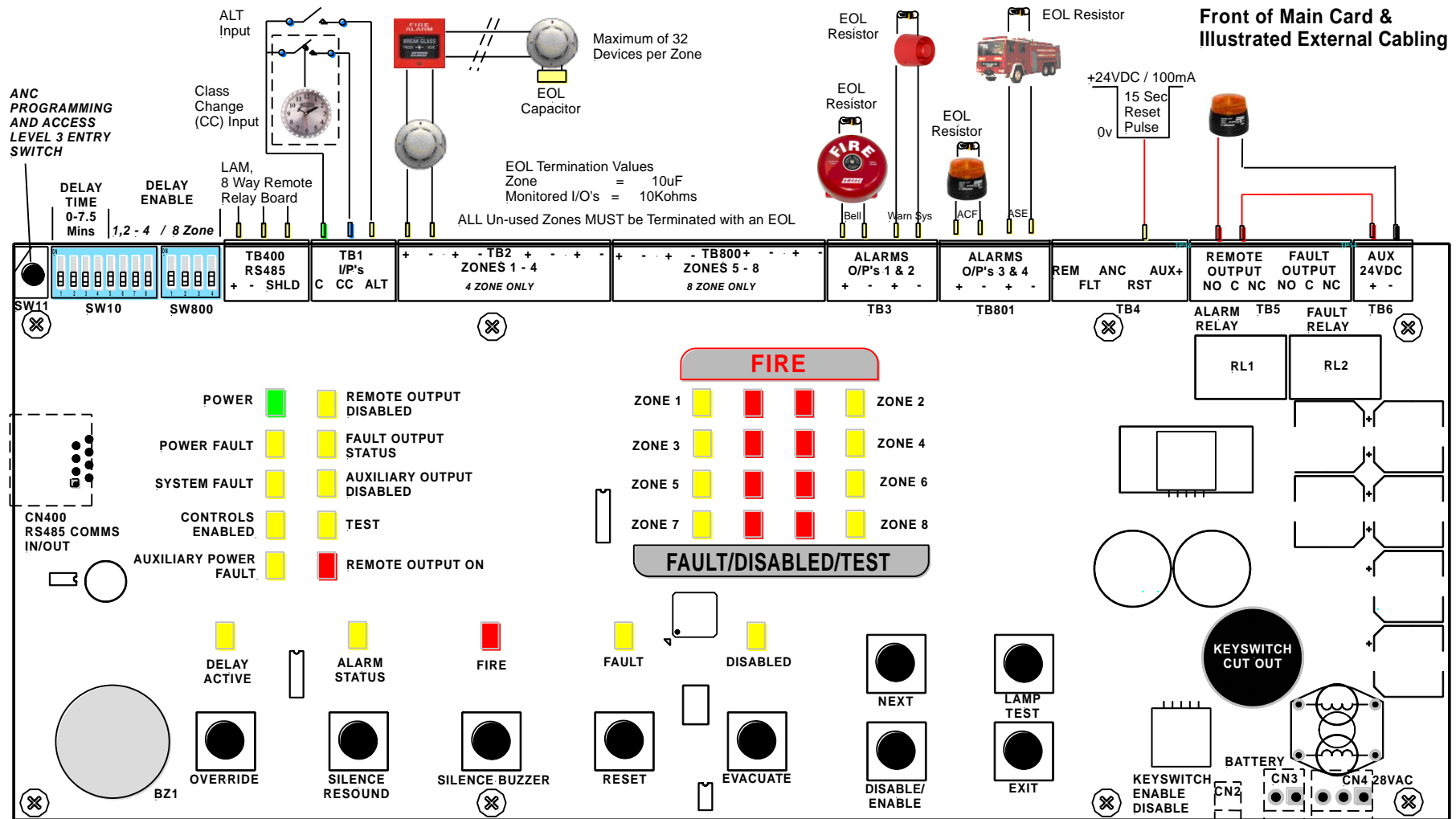

Figure 15: Main Control Board Layout & Typical External Cabling

8 Ancillary Modules

Note: Ancillary modules are only supported in the 4 & 8 zone versions.

The FACP has the ability to “learn” the type and address of connected ancillary modules. There is support for

1. Four (4) LAM cards and
2. One (1) Internal or one (1) External 8 way Relay Board.

LAM cards must be set to address 1 through 4 and depending on the required functionality the 8 way Relay Board set to address 1 or 2.

8.1 Programming Ancillary Modules

To program the number and type of ancillary modules, connect the modules to the FACP, enter access level 3, and then depress the programming pushbutton for 3 seconds. The buzzer will beep for 1 second confirming the connected ancillary module/s have been programmed

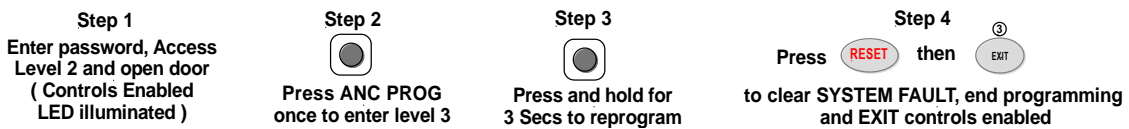

8.2 8 Way Relay Board

The Relay Board provides 8 X 1A voltage free changeover contacts for control and or monitoring purposes and can be mounted internally or externally to the cabinet. RS485 communications / connection to the Main Control Board is via terminals TB400 1 (+ve), 2 (-ve) and 3 (Shield).

The Relay Board has been designed to operate in two ways.

1. If the address of the Relay Board is set to 1 (see below), then when any zone circuit reports an alarm ALL 8 relays will be activated.
2. If the address of the Relay Board is set to 2 (see below), then:
 - I. Relay 1 will be activated when zone circuit 1 reports an alarm; relay 2 will be activated when zone circuit 2 reports an alarm. This continues for relay 3 (zone circuit 3) up to relay 8 (zone circuit 8)
 - II. If the relay board is connected to a 2 zone model, then relays 3 to 8 will be activated if any zone circuit is in alarm
 - III. If the relay board is connected to a 4 zone model, then relays 5 to 8 will be activated if any zone circuit is in alarm.



Address switch set to 1.

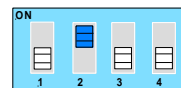

Address switch set to 2

Note: In all cases, the relays remain activated until the reset control is activated.

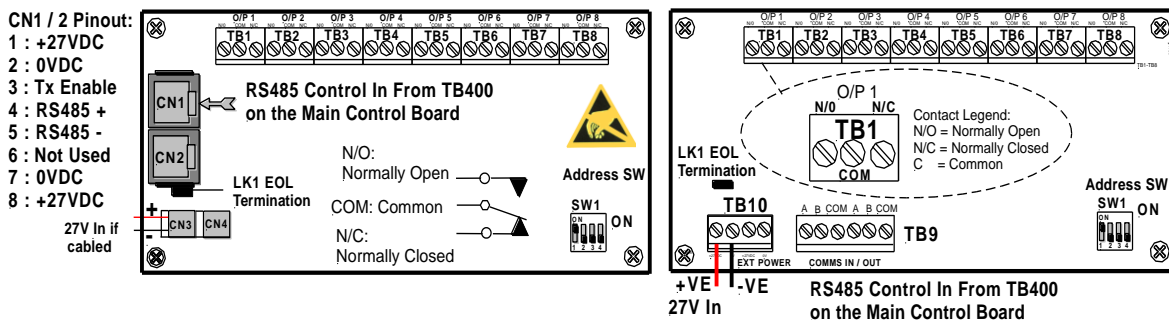

Figure 16: Internal & External Relay Board Connection Detail and Board layout

8.3 LED Annunciator Master (LAM) Card

LED annunciators (LAM's);

- Are used to display fire system information at locations that are remote from the FACP.
- Have common FACP controls, status indicators, eight alarm and eight fault/disable/test indicators;
- Generally are located in the front entrance of buildings, or in areas that are occupied by people who are responsible for responding to an emergency.
- Contain all communications interfacing and power supply circuitry.
- Controls, LAMP TEST and SILENECE BUZZER have tactile and audible feedback (0.25 second tone burst) of operation.
- Terminals are a plug-in type and cater for up to 2.5mm cables.

Communications

Communications is, RS485+, RS485-, and Screen. The communications is based on half duplex RS485. The RS485+ and RS485- carry the data and allow the LAM to communicate with the FACP. The Screen terminal is an equalisation wire to ensure the LAM and the FACP are at the same voltage potential. The LAM must therefore be powered by a supply which is isolated from any earth connections. A 4 way DIP switch sets the LAM address and the termination link (LK) must be inserted on the last card.

3 RS485 communications IN and 3 RS485 communications OUT terminals are provided

Power Supply

The LAM operates from 24VDC so 2 power IN and 2 power OUT terminals are provided. To meet the requirements of communication interfacing an isolated DC to DC converter is used.

LAM Buzzer

The buzzer is fitted to the PCB and provides audible:

- Indication of a fire condition. Tone is continuous until the fire condition is cleared by a reset or the buzzer is silenced locally or at the FACP
- Indication of a fault condition. Tone is 1 second on, 1 second off, until the fault condition clears or the buzzer is silenced locally or at the FACP.
- Feedback when a key is pressed. Tone is 0.25 second burst

In addition the buzzer:

- Can be silenced by front panel control.
- Resounds on any new alarm or fault condition.
- Sounds during a lamp test.
- Will not sound during alarm, fault or walk tests. This is handled by the FACP

Summary of Terminations

Terminal Number	Terminal Description	Terminal Operation/Build Option
Communications (CON1862)		
1	RS485 +ve	Incoming communications cabling
2	RS485 -ve	
3	Shield	
4	RS485 +ve	Outgoing communications cabling
5	RS485 -ve	
6	Shield	
Power (CON1862)		
7	+ 24VDC	Incoming power cabling
8	0VDC	
9	+ 24VDC	Outgoing power cabling

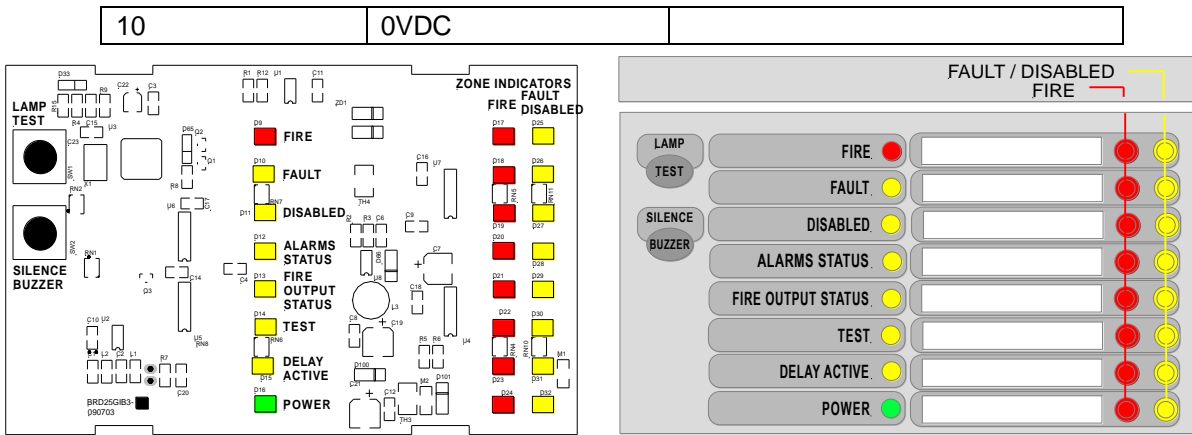

Figure 17: LAM Top PCB Overlay & Front Panel Controls & Indicators

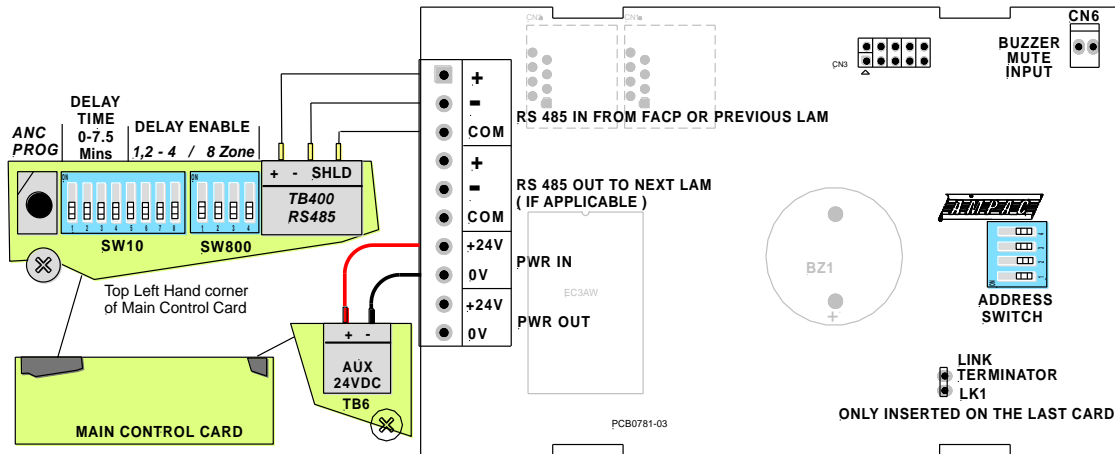

Figure 18: LAM Bottom PCB Overlay

8.4 Summary of Typical Ancillary Board Specifications

	Relay Board Internal	Remote Relay Board	LAM
Operating Voltage:	24VDC	24VDC	24Vdc
Standby Current:	2.4mA	16mA	<15mA
Alarm Current:	80mA	80mA	>15mA
Operating Temperature:	-5° to +55° C	-5° to +55° C	-5° to +55° C
Cabling Distance	N/A	Up to 1200m	Up to 1200m

Note: It is recommended the above specifications are taken into account when calculating the battery capacity for the installation.

9 Configuration

A label is fitted to all FACP's so as the installer can record the configuration of the installation.

ZONE	ZONE TYPE	TIME DELAY (min:sec)*	
1	NORMAL / DELAYED	0:00	0:30
2	NORMAL / DELAYED	1:00	1:30
3	NORMAL / DELAYED	2:00	2:30
4	NORMAL / DELAYED	3:00	3:30
5	NORMAL / DELAYED	4:00	4:30
6	NORMAL / DELAYED	5:00	5:30
7	NORMAL / DELAYED	6:00	6:30
8	NORMAL / DELAYED	7:00	7:30
ANCILLARY BOARDS		TICK TO INDICATE DELAY * TIME DELAY COMMON TO ALL ZONES	
TYPE	FITTED	NOT FITTED	CODE
RELAYS			EN54: 2&4 / ISO7240: 2&4
No ANNUNCIATORS	1	2	3
			4



Figure 19: Configuration Label Fitted to the Front Door

10 Compatible Devices

Apollo Series 65

ORDER CODE

Heat - A1R	55000-122
Heat – BR	55000-127
Heat – CR	55000-132
Heat – CS	55000-137
Smoke - Photo Optical	55000-317
Smoke – Ionisation	55000-217
Smoke – Integrating Ionisation	55000-220
Detector Base	45681-200
Detector Base - Relay	45681-360

Apollo Orbis

Smoke Photo Optical FL/LED	201-0502
MultiSensor FL/LED	201-0506
Heat A1R FL/LED	201-0510
Heat A2S FL/LED	201-0518
Heat BR FL/LED	201-0514
Heat BS FL/LED	201-0522
Heat CR FL/LED	201-0526
Heat CS FL/LED	201-0530
TimeSaver Base®	201-0536
TimeSaver Diode Base	201-0538
TimeSaver Relay Base	201-0539

Hochiki CDX Conventional Series

Smoke - Photo Optical	228-SLR-E3
Combined Heat Detector Grade 1 60C	228-DCD-AE3
Combined Heat Detector Grade 1 90C	228-DCD-CE3
Fixed Temperature Heat Detector 60C	228-DFJ-AE3
Fixed Temperature Heat Detector 90C	228-DFJ-CE3
Detector Base With Remote Indicator Output	228-YBN-R/6
Schottky Diode Base With Remote Indicator Output	228-YBN-R/6SK
Zener Diode Base with Remote Indicator Output	228-YBO-R/5ZD
Protector Alarms Base with Remote Indicator Output	228-YBO-R/6PA
12V Relay Base	228-YBO-R/12V
YBO Base Kit	228-YBO-R/Kit
Smoke - Photo Optical - black	228-SLR-E BL
Conventional Base - black	228-YBN-R/4 BL
Smoke - Intrinsically Safe, Photo Optical	228-SLR-E-IS
Detector Base - Intrinsically Safe	228-YBN-R/4IS
UV Flame Detector c/w 228-YBF-RL/4H5 mounting Base	228-HF-24
Waterproof Fixed Temperature Heat Detector	228-DFG-60E

Sounders

Vara Sounder - Red	205-0027
Vara Sounder - White	205-0028
Vector Sounder (no lid) - White	205-0011
Vector Sounder Lid Only - White	205-0017
Vantage Sounder - Red with Shallow Base	205-0070
Vantage Sounder - White with Shallow Base	205-0071
Vantage Combi - Red with Shallow Base	205-0075
Vantage Combi - White with Shallow Base	205-0076
Vantage Deep Base Only – Red	205-0064
Vantage Deep Base Only – White	205-0065

Manual Call Points

Conventional Call Point Red 470R (Without Back box)	213-CX/G/R/NB
Keyswitch (including Back Box)	213-CXK/2/R/BB
Standard Back Box (pack of 10)	213-CXBB/R
IP 67 Conventional Call Point Red 470R	213-CX/G/R/IP
Conventional Call Point Red 470R (Without Back box)	213-CX/G/R/NB
Conventional Call Point LED Red 470R (Without Back box)	213-CXL/G/R/NB
Polycarbonate Cover (pack of 10)	213-CXPC
Spare Glass (pack of 10)	213-CX/SG

11 Calculating Standby Battery Capacity

The minimum capacity of valve regulated lead acid batteries as recommended in BS 5839 – 1 : 2002 should be calculated using the following formula;

$$C_{\min} = (T_1 I_1 + D I_2 / 2)$$

Where;

C_{\min}	=	the minimum capacity of the battery required when new at the 20 h discharge rate and at 20°C in ampere - hours;
T_1	=	total battery standby period in hours (see recommendations of EN54-4)
I_1	=	total battery standby load in amps
I_2	=	total battery alarm load in amps
D	=	the de-rating factor

Criteria

Where $C_{\min} / 20$ will be equal to or greater than I_2 , it can be assumed that $D = 1$. When $C_{\min} / 20$ is less than I_2 the value of D should either be based on the battery manufacturer's data or should be 1.75.

In practice, $C_{\min} / 20$ is unlikely to correspond exactly to an available battery capacity and therefore the next highest available capacity size should be used.

Batteries other than valve-regulated lead acid batteries

The minimum capacity of batteries, other than valve regulated lead acid batteries, should be determined by consultation with the battery manufacturer and should take into account the standby load, the alarm load, any required de-rating to take account of the higher current drawn in the alarm condition and a de-rating factor to take account of battery ageing during the anticipated life of the battery.

NOTE: Automotive batteries SHOULD NOT be used.

Note:

Alarm outputs were loaded to 300mA and the open collector outputs were loaded to 50mA for max current draw measurements

All Quiescent current measurements checked with sounder & buzzer silenced.

All Alarm current measurements checked with sounder & buzzer silenced.

Current Draw (Typical Figures)

Condition	2 Zone	4 Zone	8 Zone
Quiescent current stand alone =	20mA	20mA	21mA
1 zone in Alarm current draw =	40mA	40mA	51mA
All zones in Alarm current draw =	41mA	43mA	56mA
Quiescent current relay board fitted =	N/A	24mA	25mA
Quiescent current LAM fitted =	N/A	34mA	35mA
Max current draw =	1027mA	1073mA	1580mA

12 Trouble Shooting

If a Fault occurs on a critical part of the System, the Panel responds by activating its internal Buzzer and illuminating the common FAULT light and any other fault light(s) relating to the fault. The Panel's Fault Output will also activate (provided it has not been Disabled).

Possible faults indicated at the Panel are highlighted below.

Unless otherwise stated, repairing any particular fault condition will automatically clear the fault from the Panel. If the Panel is RESET while a fault still exists a fault will still be indicated.



Note: It is possible to mute the Panel's BUZZER at any time by momentarily pressing the SILENCE BUZZER button.

GENERAL

Fault

The Common FAULT LED is illuminated (amber) when there is a fault on any part of the Fire Alarm System. It is always lit in tandem with at least one other fault LED which conveys more precise information on the type of fault detected.

Zone Fault

All of the Panel's Zone circuits are monitored for open and short circuit faults and detector head removal if diodes have been installed. (unless there is an Alarm condition or the Zone is in test or disabled). All faults are indicated by the relevant ZONE FAULT indicator pulsing amber.

FAULT STATUS

Power

The POWER ON LED should be illuminated at all times. If the mains supply fails the LED will flash, see Power Supply Faults for further information.

Power Supply Fault

The POWER FAULT LED is illuminated (amber), the Common FAULT LED is illuminated (amber) and the POWER LED (green) flashes when one or more of the following has occurred:

- The Mains supply is too low or has failed completely.

Symptoms: The panel runs on batteries but not on Mains

Suggested Action: Measure for 240 / 28VAC on the primary / secondary sides of the transformer and the 28VAC on the Main Control Board.

Carefully disconnect the batteries and measure the 27V output of the Power Supply

- The Mains fuse has ruptured.

Symptoms: The Panel runs on batteries but not on Mains

Suggested Action:

- Isolate the Mains supply, and check the PSU's Primary Mains fuse for continuity.
- If the Fuse is ruptured it will be due to excessive Mains surge or a PSU fault. Check the components on the PSU for damage. If none is found replace the fuse with the correct type and reconnect the Mains supply.

- The Battery supply voltage is too low.

Symptoms: the Panel runs on Mains but will not run on batteries. If the Mains supply has failed and the battery supply has been discharged to the point where the voltage is too low (i.e. less than 21V), the Panel will automatically turn off to avoid damaging the batteries by allowing them to deep discharge. The Panel will not restart unless fresh, fully charged batteries are connected, or the Mains supply is restored.

If the Mains supply has not failed, but the total battery voltage is less than 21V, the PSU will not charge the batteries to avoid damage to the charging circuit. If the batteries can be charged, the Panel will still show a power supply fault until they have sufficient charge, at which point the power supply fault will automatically be cleared. Depending on battery size and the depth of discharge, this

may take several hours. If the batteries are in poor condition they must be replaced. Please note that the charging circuit is set up during manufacturing, and is temperature compensated. There is no need to adjust the voltage.

If the batteries are in good condition and all the other checks have been performed and no faults found, the Main Control Board is faulty.



Note: Batteries that are not connected, connected in reverse or with opposite polarities will also cause a power supply fault condition.

System Fault

The System Fault light flashes yellow when one or more of the following has occurred:

- There is a microprocessor Watchdog fault.
- The microprocessor's Site Memory has been corrupted .
- There is a fault on the microprocessor.
- The Main Control PCB is faulty.

Watchdog Fault

Normally this type of fault occurs when there is a problem with the microprocessor (perhaps due to excessive electrical interference). Pressing the RESET button should clear the fault.

Site Memory or Settings

This can be caused by electrical interference or a faulty or dirty programming DIL switch and can be simply cleared by a RESET or working the switch several times and apply and appropriate cleaner.

Alarms Monitored Output Fault

Circuits are monitored for open and short circuit faults (unless Disabled or in an Alarm condition).

If any faults are detected, the Panel's ALARMS STATUS indicator flashes and the COMMON FAULT LED is illuminated.

To determine which circuit is faulty;

Disconnect each circuit from the Main Control Board and measure the resistance of each circuit. The EOL resistance value (10KΩ) should be the result, any other values indicate a fault.

If the measurements are correct connect EOL's to the Alarms circuits at the Main Board without the wiring. If the fault is in the circuit the fault will clear, if not the Main Board is faulty.



Note: If the circuit is shorted the circuit will be current limited to 250mA.

Auxiliary Output Fault

The AUXILLIARY POWER FAULT LED is illuminated if there is a fault e.g. S/C on the output Aux. 24V supply.

Zone Fault

The Zone in fault will be indicated on the front panel. To determine if the panel or the circuit is at fault, disconnect the Zone wiring from the Main Control Board and connect an EOL to the board. If the wiring is at fault the panel will return to normal, if not the Main Control Board is at fault.

If the wiring is at fault check to ensure

- All detectors are clean, firmly seated in their base and undamaged,
- The EOL is correct, and look for any obvious signs of damage to the wiring

Ancillary Module Faults

The FAULT LED will be illuminated

13 Definitions

Addressable Device – an addressable input and/or output device.

Alarm zone - the specific portion of a building or complex identified by a particular alarm zone facility.

Alert signal - an audible signal, or combination of audible and visible signals, from the emergency warning system to alert wardens and other nominated personnel as necessary to commence prescribed actions.

Ancillary equipment - remote equipment connected to FACP.

Ancillary relay - relay within FACP to operate ancillary equipment.

Ancillary output - output for driving ancillary equipment.

Approved and approval - approved by, or the approval of, the Regulatory Authority concerned.

Board / Card – a fully assembled Printed Circuit Board (PCB).

Cabinet – the empty cabinet used to house a Fire Alarm Control Panel.

Card-detect link - a link on a module connector to indicate the disconnection of the module.

Conventional System - is a fire detection system using a dedicated circuit for each alarm zone.

Disable - a status indicating that the system is not in a normal state, typical due to a zone, detector or device being inhibited from sending a signal to the MAF.

Distributed system - a fire alarm and detection system where sections of the control and indicating equipment are remotely located from the fire indicator panel or where sub-indicator panel(s) communicate with a main fire indicator panel.

Evacuate signal - an audible signal, or combination of audible and visible signals, from the emergency warning system to alert all personnel to commence an evacuation.

Factory connections - connections made during manufacture that do not require any field alterations.

Field connections - are connections made to FACP or ancillary equipment at the project during installation.

Fire alarm system - an arrangement of components and apparatus for giving an audible, visible, or other perceptible alarm of fire, and which may also initiate other action.

Fire detection system - an arrangement of detectors and control and indicating equipment employed for automatically detecting fire and initiating other action as arranged.

Fire Alarm Control Panel (FACP) - a panel on which is mounted an indicator or indicators together with associated equipment for the fire alarm or sprinkler system.

Front Panel – the fascia of a Front Panel Board, generally consisting of controls, indicators and labelling.

Indicating equipment - the part of a fire detection and or alarm system, which provides indication of any warning signals (alarm and fault), received by the control equipment.

Interface - The interconnection between equipment that permits the transfer of data.

LAM – a visual representation of a fire detection system, using LED's.

Printed Circuit Board (PCB) – an unpopulated Board.

Power Supply - that portion of the control and indicating equipment (FACP) which supplies all voltages necessary for operation of the FACP.

Regulatory Authority - an authority administering Acts of Parliament or Regulations under such Acts.

14 Glossary of Terms

ACF:	ANCILLARY CONTROL FACILITY
ALM:	ALARM
ANC:	ANCILIARY
AUX:	AUXILIARY
BATT:	BATTERY
C:	RELAY COMMON CONTACT (WIPER)
CN:	CONNECTOR
CPU:	CENTRAL PROCESSOR UNIT
ETH:	EARTH
EOL:	END OF LINE
EVAC:	EVACUATE
FACP:	FIRE ALARM CONTROL PANEL
F.A.R.E:	FIRE ALARM ROUTING EQUIPMENT
F.W.R.E:	FIRE WARNING ROUTING EQUIPMENT
FLT:	FAULT
GND:	GROUND (0 VOLTS) NOT EARTH
I/O:	INPUT/OUTPUT
LAM;	LED ANNUNCIATOR MASTER
LED:	LIGHT EMITTING DIODE
MAF:	MASTER ALARM FACILITY
MCP:	MANUAL CALL POINT
MON:	MONITOR
N/C:	NORMALLY CLOSED RELAY CONTACTS
N/O:	NORMALLY OPEN RELAY CONTACTS
O/C:	OPEN CIRCUIT
O/P:	OUTPUT
S/C:	SHORT CIRCUIT
PCB:	PRINTED CIRCUIT BOARD
P/S:	POWER SUPPLY
PSE:	POWER SUPPLY EQUIPMENT
PTC:	POSITIVE TEMPERATURE CO-EFFICIENT (THERMISTOR)
REM:	REMOTE
RST:	RESET
SHLD:	SHIELD
TB:	TERMINAL BLOCK
VAC:	VOLTS ALTERNATING CURRENT
VDC:	VOLTS DIRECT CURRENT

15 Specifications

Power Supply

Mains Supply Voltage		204 to 264VAC 47 – 63 Hz
Minimum Cable Requirements		Not less than 1 ² mm
Main Control Board Power Supply		Set to 27.2VDC - Modulated: 27.2V with no alarm condition, with the battery fully charged and the ambient inside cabinet temperature is 25°C
Power Supply Output Current Limiting		2 & 4 Zone 1A, 8 Zone max current 1.6A
P/S, Battery Charger and Battery Monitoring		Yes
Battery Over Discharge Protection		Yes (Deep discharge cut off 21.2VDC)
Max. Battery Size and Type		2 X 12V - 7AH sealed lead acid connected in series
Mains Fuse		0.5A
Supply Fault Indication	Volts High	28VDC
(at room temperature)	Volts Low	23.5V
Main Board quiescent current		2 Zone: 20mA, - 4 Zone: 20mA, - 8 Zone: 21mA

Dimensions

ABS Cabinet	360mm W x 300mm H x 80mm D (recessed depth)
Metal Cabinet	356mm W x 295mm H x 92mm D (flush mounting only)

Environmental Operating Conditions

Temperature range	-5°C to +55°C
Relative humidity	25% to 75%

Detector Circuits

Number of Circuits	2, 4 or 8 availability
Zone circuit monitoring	Open and short circuit
Maximum quiescent detector current	4mA
Zone circuit EOL value	10uF
Zone alarm delay (enable programmable)	0:30 seconds to 8 minutes
Zone circuit detector removal monitoring	To maximum of 20 detectors
Maximum cable length / DC Resistance	3km / 50 Ω
Maximum cable capacitance	1μF
Recommended Cable Size	2 core 1.5 ² mm to 2.5mm
Recommended MCP internal resistor value	470Ω to 680Ω
Short circuit Current limiting per zone	25mA
Max. number of detectors & MCP's per zone	32 – influenced by the number of different devices

Sounder Circuits

Number of sounder circuits	2 Zone: 2	4 Zone: 2	8 Zone: 4
End of line (EOL) resistor value	10KΩ		
Circuit monitoring	Open and short circuit (Fault indication self resetting)		
Alarm voltage	27VDC max. to min. battery voltage		
Circuit current limitations	Current limited to 250mA per circuit		

Auxiliary Outputs

Max. output current 1 to 4	Switching - 40mA only
1. Remote output	Un-monitored open collector, S/C protected
2. Ancillary output	Un-monitored open collector, S/C protected
3. Fault output	Un-monitored open collector, S/C protected
4. Reset output	15sec. +24VDC to 0VDC @ 40mA
5. Auxiliary 27VDC output	+27VDC 150mA max

Auxiliary Inputs

Class Change - Un- Monitored, non-latching	Required I/P- 0VDC to operate - closing contact
Alert - Un- Monitored, non-latching	Required I/P- 0VDC to operate - closing contact

Communications

Comms to LAM's and / or Relay Board	RS485 – 4 and 8 Zone versions ONLY
-------------------------------------	------------------------------------

UNCONTROLLED DOCUMENT

NOTE: Due to AMPAC's commitment to continuous improvement specifications may change without notice.